



AP-B

Dental Scaler and Air Polisher Instruction Manual

Please read this manual before operating

CE 0197

ZMN-SM-491 V1.4-20230221

GUILIN WOODPECKER MEDICAL INSTRUMENT CO., LTD.

Contents

Preface.....	1
1 Introduction.....	1
2 Installation and Operation.....	2
3 Troubleshooting	9
4 Cleaning, Disinfection and Sterilization	13
5 Maintenance, storage and transportation	18
6 Environment protection	19
7 After service	19
8 European authorized representative.....	20
9 Symbol instruction	20
10 EMC-Declaration of conformity.....	21
11 Statement.....	25

Preface

Guilin Woodpecker Medical Instrument Co., Ltd is a professional manufacturer researching, developing, and producing dental products. Woodpecker owns a sound quality control system and two brands, Woodpecker and DTE. Its main products include dental scaler, dental air polisher, Ultrasurgery, root canal motor, Curing light, dental implant unit, endo motor, etc.

1 Introduction

AP-B dental scaler and air polisher has both ultrasonic system and airpolishing system. The device features include:

- 1) Automatically switch the working mode according to the selected handpiece.
- 2) Water and power can be adjusted.
- 3) Special pharmaceutical products such as hydrogen peroxide, sodium hypochlorite and chlorhexidine can be used in automatic water supply mode to improve clinical therapeutic effect.
- 4) Ultrasonic handpiece LED lights make clinical operation more convenient. Airpolishing handpiece adopts three-section design, which is easy to load and unload, and convenient to clean and maintain.
- 5) The handpiece can be free to plug, and can be sterilized in the environment of 134°C and 0.22MPa pressure.

1.1 Product model

AP-B

1.2 Product Configuration

For more information, see packing list.

1.3 Structure and components

It mainly consists of main unit, ultrasonic handpiece, airpolishing handpiece, tips, nozzle, foot switch, powder tank, water bottle, power adapter, prophylaxis powder, etc.

1.4 Intended use

AP-B Dental Scaler and Air Polisher is suitable for periodontal treatment and root canal irrigation in dental clinical treatment. It can remove supragingival and subgingival calculus and plaque, so as to achieve the therapeutic effect of consolidating periodontal tissue.

1.5 Contraindication

- 1.5.1 The hemophilia patient is forbidden to use this device.
- 1.5.2 The patients with heart pacemaker are forbidden to use this device.
- 1.5.3 The doctors with heart pacemaker are forbidden to use this device.
- 1.5.4 Heart disease patients, pregnant women and children should be cautious to use the device.

1.5.5 Patients with respiratory diseases such as asthma and chronic bronchitis are not allowed to use this device.

1.6 Equipment security classification

1.6.1 Classification by operation mode: Continuous operating device

1.6.2 Type of protection against electric shock: Class I

1.6.3 Degree of protection against electric shock: B type applied part

1.6.4 The contact duration time of applied part:

Tips: Less than 30 minutes

Nozzle: Less than 10 minutes

1.6.5 The temperature of the surface of nozzle may reach 45°C if it is used at maximum power.

1.6.6 Degree of protection against harmful ingress of water: Ordinary equipment (IPX0). Foot switch is anti-drip device (IPX1).

1.6.7 Degree of safety application in the presence of a flammable anesthetic mixture with air, oxygen, or nitrous oxide: Equipment cannot be used in the presence of a flammable anesthetic mixture with air, oxygen, or nitrous oxide.

1.7 Main technical specification

1.7.1 Power adapter input: 100-240V~ 50/60Hz 1.1A Model: USE48-300130SPA3

1.7.2 Main unit input: 30V === 1.3A

1.7.3 Main vibration offset of output tip (maximum):100μm, deviation: ± 50%

1.7.4 Output tip vibration frequency: 30±5kHz

1.7.5 Output half offset force (maximum):10N deviation: ± 50%

1.7.6 Output power of tip: 3W ~ 20W

1.7.7 Main unit insurance: T1.6AL 250V

1.7.8 Air inlet pressure: 5.5bar ~ 7.5bar (0.55MPa ~ 0.75MPa)

1.7.9 Main unit weight:2.0kg

1.7.10 Main unit size: length×width×height 270mm×170mm×90mm

1.8 Operation environment

1.8.1 Environment temperature: + 5°C ~ + 40°C

1.8.2 Relative humidity: 30% ~ 80%

1.8.3 Atmospheric pressure: 70kPa ~ 106kPa

1.9 Intended place of use

Professional healthcare facility environment.

2 Installation and Operation

2.1 Main unit and main accessories display

2.1.1 Front view of main unit

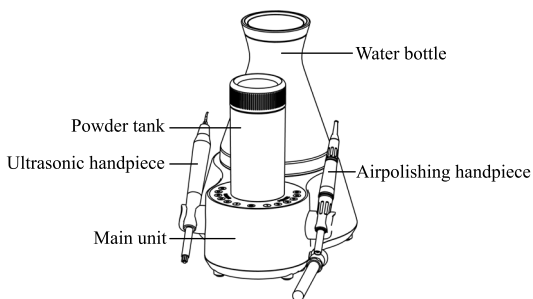

Fig. 1 Front view of main unit

2.1.2 Back view of main unit

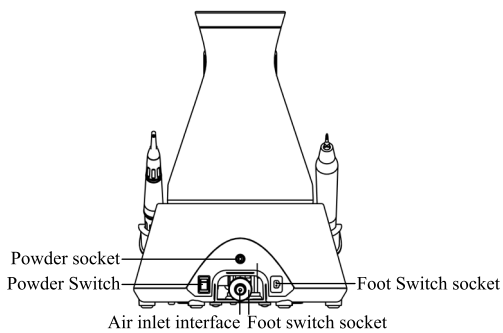

Fig. 2 Back view of main unit

2.1.3 Touch panel

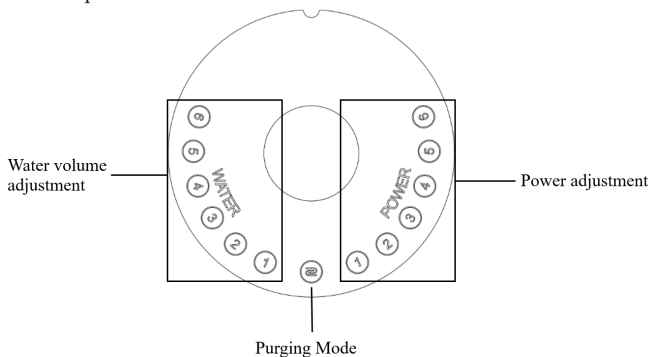

Fig. 3 Touch panel

After power on, the button will be blue. If there is no air connection or the air pressure is insufficient, the blue light flashes.

2.1.4 Schematic diagram of handpiece

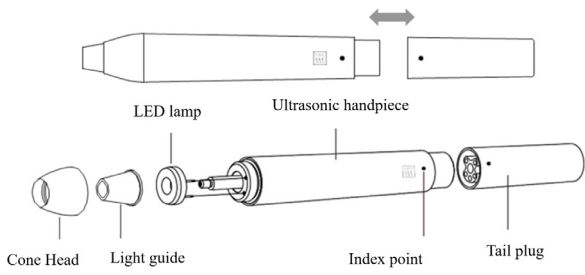

Figure 4 ultrasonic handpiece

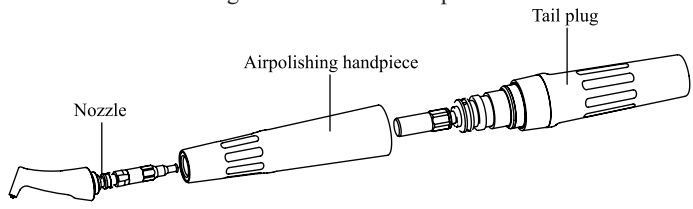

Fig. 5 Airpolishing handpiece

2.1.5 Installation diagram of tip

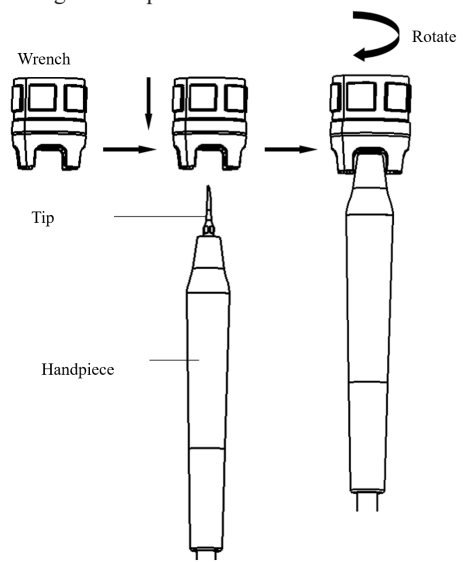

Figure 5 Installation diagram of tip

2.2 Main unit installation

- 1) Open the package, check whether all the accessories of this equipment are complete according to the packing list, and put the main unit on the stable

desktop to the operator.

2) Take out the foot switch and insert the connector into the corresponding foot switch socket on the back of the main unit.

3) Take out the external air pipe and connect the air pipe joint with the air inlet interface on the back of the main unit.

4) Put the power switch in the off state, insert the output plug of the power adapter into the power socket on the back of the main unit, and then insert the input plug of the power adapter into the power socket.

5) Release the foot pedal, the handle can stop working, and press the power switch to shut down.

[Warning 1] To avoid the risk of electric shock, this equipment must only be connected to a supply mains with protective earth.

[Warning 2] when the power adapter is connected to the network power supply, do not place or install the product in a place where it is difficult to cut off the network power supply.

[Warning 3] Unauthorized modification of this equipment is not allowed.

[Warning 4] This equipment cannot be used in areas where liquids may appear on the floor such as emergency rooms or surgical operating rooms.

[Warning 5] This equipment can only be used by professionals with a physician or nurse license.

[Warning 6] The device is expected to be connected to an independent power supply, and the power supply shall be specified as part of the device or the combination of device and power supply shall be specified as the ME system.

[Warning 7] Use of this equipment adjacent to or stacked with other equipment should be avoided because it could result in improper operation. If such use is necessary, this equipment and the other equipment should be observed to verify that they are operating normally.

[Warning 8] Use of accessories, transducers and cables other than those specified or provided by the manufacturer of this equipment could result in increased electromagnetic emissions or decreased electromagnetic immunity of this equipment and result in improper operation.

2.3 Instructions

2.3.1 Handpiece connection and disassembly

Take out the ultrasonic handpiece, install the tip on the handpiece with wrench, twist the wrench. Then connect the ultrasonic handpiece with the ultrasonic line and put the handpiece on the bracket on the left side of the main unit.

Take out the airpolishing handpiece, connect the air polishing handpiece with the airpolishing line, and place the handpiece on the bracket on the right side of the main unit.

2.3.2 Filling with prophylaxis powder

Take out the powder tank and use the three way syringe to blow away the residual powder. Take out the prophylaxis powder, hold the bottle and shake it

3-5 times, then pour the powder into the powder tank.

When the powder in the powder tank is used up, please click the “Purging Mode” button twice to remove the compressed air in the powder tank, and then add powder into powder tank. It is unallowed to add powder when in use.

[Tip 1] Do not exceed the maximum (MAX) mark.

[Tip 2] The supragingival powder can only be used in the supragingival powder tank. The subgingival powder can only be used in the subgingival powder tank.

2.3.3 Filling with water

Take out the water bottle, add purified water (or distilled water) to the water bottle, and then plug the water bottle into the main unit. A small amount of Vaseline can be applied to the seal ring at the bottom of the water bottle to lubricate the seal ring, which is convenient for the water bottle to plug.

2.3.4 Scaling

2.3.4.1 Turn on the power switch of the main unit and pick up the ultrasonic handpiece.

2.3.4.2 Assess the patient's oral condition, set the power and water level in advance. It is recommended that the power starts from the 2nd gear, and the water volume starts from the 3rd gear. According to the sensitivity and comprehensive situation of the patient's oral cavity, adjust the water and power level at any time during the scaling process.

2.3.4.3 Select an appropriate tip as needed and tighten it on the handpiece with the wrench.

2.3.4.4 Press on the foot switch, then the tip vibrates, LED on the head of the handpiece lights, accompanied by water injection . After releasing the foot switch, the vibration and water stops, and the LED light continues to shine for 10 seconds and then goes out.

2.3.4.5 Hold the handpiece like holding a pen.

2.3.4.6 When the machine works normally, the frequency is extremely high. Under the condition of ensuring tip vibrate normal, only side surface of tip should be used to gently touch the tooth surface and there is no obvious fever in tip; Do not use too much force or stay too long when scaling.

2.3.4.7 Please keep zero angular contact between the side of tip and the tooth surface during scaling, and let the tip vibrate freely without applying pressure.

2.3.4.8 After scaling, let the device work for 30 seconds with the water to clean the handpiece and tip.

2.3.4.9 Remove tip for disinfection.

2.3.5 Air polishing

2.3.5.1 Assess the patient's oral condition, set the power and water level in advance, and It is recommended that the power starts from the 2nd gear, and the water volume starts from the 3rd gear.

According to the sensitivity and comprehensive situation of the patient's oral cavity, adjust the water and power level at any time during the scaling process.

2.3.5.2 Before the treatment, please spray in the external container for 1-3 seconds in advance to ensure that the gas and water are evenly sprayed.

2.3.5.3 Before air polishing, please wear goggles and veil. Users should wear goggles or protective masks.

2.3.5.4 Hold the handpiece like holding a pen.

2.3.5.5 Make the nozzle align with the tooth surface. It is recommended that the nozzle outlet keep a distance of 3-5mm from the tooth surface. It is recommended that the air polishing direction and the tooth surface show an angle of 30°-60°, as shown in figure 6.

2.3.5.6 Use the high-speed evacuation equipment on the dental comprehensive treatment machine to absorb the air/powder mixture reflected from the tooth surface during treatment.

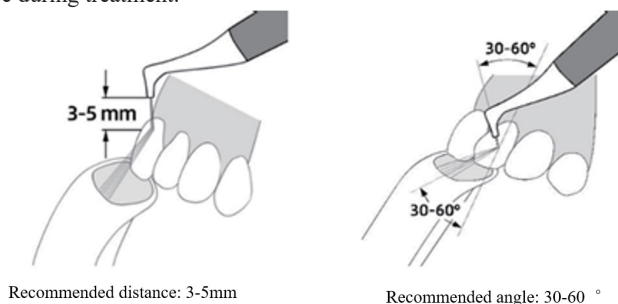

Fig. 6 schematic diagram of grit blasting on gum

2.3.5 Subgingival airpolishing

2.3.5.1 When the depth of the patient's periodontal pocket exceeds 4mm, subgingival airpolishing is recommended.

2.3.5.2 Install the nozzle before use, take out the nozzle assemble the nozzle to the end of the subgingival handpiece. Rotate the nozzle nut to the head handpiece first, and then lock the nozzle with a wrench, as shown in Fig. 6.

2.3.5.3 Assess the periodontal condition of patients and set the power and water level in advance. It is recommended that the power starts from the 1st gear and the water starts from the 3rd gear. Adjust the water and power level at any time during the scaling process according to the periodontal sensitivity and oral comprehensive situation of patients.

2.3.5.4 Hold the handpiece like holding a pen.

2.3.5.5 It is recommended to use the nozzle to remove the plaque of the 4-9mm depth periodontal pocket, pull up and down when using.

2.3.5.6 It is not allowed to polishing the periodontal pocket at each point for more than 5 seconds. [Tip 3] It is forbidden to pull out the handpiece in the working state.

[Tip 4] When subgingival airpolishing, it's just allowed use subgingival powder, and misusing powder may cause harm to patients.

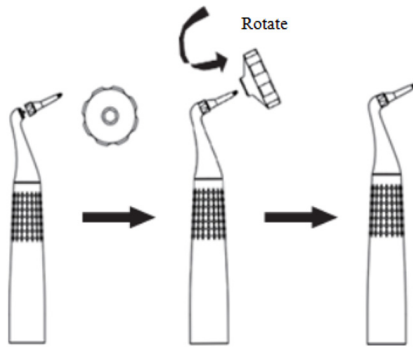

Fig. 7 Nozzle locking

2.4 Maintenance

2.4.1 Air polishing handpiece

2.4.1.1 Remove the air polishing handpiece, loosen the handpiece head and pull out the handpiece head (For subgingival handpiece, the nozzle needs to be removed in advance), as shown in figure 8.

2.4.1.2 Align the handpiece head with a three way syringe and blow away the residual powder in the handpiece.

2.4.1.3 Blow the front and rear ends of the handpiece with a three way syringe.

2.4.1.4 If the handpiece is blocked, use needle to dredge it.

2.4.1.5 Handpieces, water bottles and powder tanks should not be maintained when they are being used.

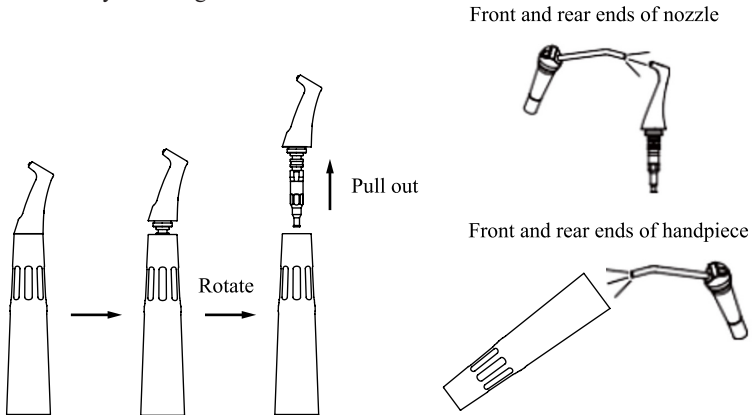

Fig. 8 handpiece cleaning diagram

2.4.2 Powder tank

2.4.2.1 It is recommended to estimate the amount of prophylaxis powder before

use. It is easy to cause blocked that leaving extra powder in the powder tank for a long time because the powder will clump in a humid environment. Therefore, please pour out the powder remaining in the powder tank after use.

2.4.2.2 Before turning off the device every day, please use an air gun to blow off the powder remaining in the powder tank, and blow off the powder on the threads of the powder tank and the threads of the powder tank cover. The powder tank that have not been cleaned for a long time may reduce the efficiency of airpolishing, and the residual powder at the threads will affect the sealing performance of the powder tank and the smoothness of the upper cover screwing.

2.4.3 Daily maintenance

2.4.3.1 Before and after using airpolishing system, please click the "Purging Mode" button on the main unit twice and the device will enter into purging mode. The purging mode duration is 20 seconds, and then stops automatically.

[Tip 5] If powder needs to be added during use, please click the "purging mode" button twice to release the high-pressure air in the powder tank to prevent powder spraying from the bottom of the powder tank when the powder tank is unplugged.

2.4.3.2 If the liquid medicine is used during the treatment, then after the treatment is completed, you must fill the water bottle with pure water (or distilled water), pick up the handpiece and press the foot pedal to let the water flow out of the handpiece to flush the pipe for at least 1 minute. The chemical liquid remaining in the pipeline will cause corrosion of metal parts such as joints and solenoid valves.

3 Troubleshooting

3.1 Description of Wearing Parts

1. The O-rings at the joint of the handpiece: the connection position of the handpiece may be damaged due to its frequent unplugging, so it needs to be replaced as needed from time to time.

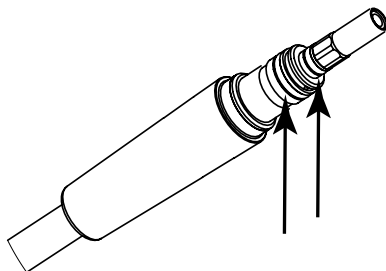

2. Sand pipe at the bottom of the main engine: there is an on-off valve to control the sand powder on and off at the bottom of the main engine, and the sand pipe

at the on-off valve may be damaged for a long time; it needs to be replaced after damage.

Expected life of sand pipe at the bottom:

Frequency of use	Expected life
1~2 times/day	4~6 years
3~4 times/day	2~4 years
5 times or more/day	1~2 years

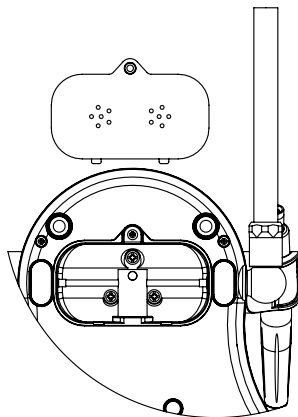

3. The sandblasting tail line of the main engine: there is a sand hose in the tail line of the sandblasting handpiece, and the wear of the hose for a long time may lead to air leakage and sand leakage of the tail line; it needs to be replaced after damage.

Expected life of sand pipe at the bottom:

Frequency of use	Expected life
1 ~ 2 times/day	4 ~ 6 years
3 ~ 4 times/day	2 ~ 4 years
5 times or more/day	1-2 years

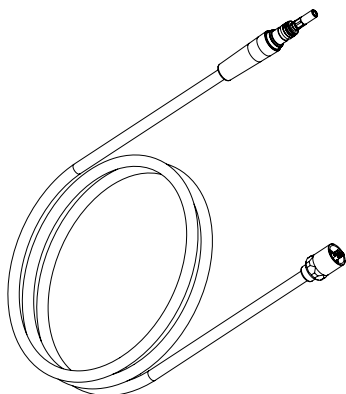

4. The O-rings in the rest of the mainframe may also be damaged due to wear and tear, which need to be replaced after the damage.

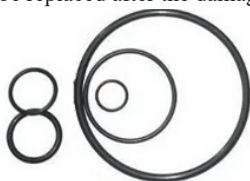

3.2 Troubleshooting

Failure	Possible cause	Solutions
Press foot switch, the tip does not vibrate and no water sprays	Poor contact of power plug.	Plug in the power plug well
	Poor contact of power plug.	Plug in the power plug well
	Bracket switch does not pop up.	Toggle bracket switch to make it pop up smoothly
Press foot switch, the tip does not vibrate but water sprays out.	The tip is not tightened.	Tighten work tip
	The connection plug between the tail line and the circuit board is loose.	Contact local distributors or manufacturer.
	Handpiece failure.	Contact local distributors or manufacturer.
Press foot switch, the tip vibrates but no water spray.	Impurities in solenoid valve.	Contact local distributors or manufacturer.
	Waterway blockage.	Use three-way syringe to dredge waterway

After power-off, there is still water spray.	Impurity in the solenoid valve.	Contact local distributors or manufacturer.
There is air flow but no water spray.	Unconnected air source or low air pressure ($\leq 3\text{bar}$).	Check the air connection and ensure that the pressure meets the requirements of the device (5bar-7bar).
	Handpiece blocked.	Use nozzle to dredge handpiece.
	Tail line blocked.	Contact local distributors or manufacturer.
	The internal pipeline of the main unit is blocked.	Contact local distributors or manufacturer.
	Solenoid valve failure.	Contact local distributors or manufacturer.
There is air and water spray, but no powder.	The powder adheres to the inner wall of the powder tank after being damp, which affects the normal flow of the powder.	Disassemble the powder tank and reinstall it after cleaning and drying.
	Incorrect match between powder tank and prophylaxis powder.	The supragingival powder tank should be match with supragingival powder. The subgingival powder tank should be match with subgingival powder.
There is air spray but no water.	Solenoid valve failure.	Contact local distributors or manufacturer.
	Solenoid Valve blocked due to impurities.	Open the main unit dredge solenoid valve or contact local distributors or manufacturer.
There is no air and water spray.	Abnormal foot switch connection.	Reconnect foot switch.
	Foot failure.	Repair or replace foot switch.

Powder tank leakage	Seal ring damaged.	Replace seal ring.
	The upper cover of the powder tank is not screwed in place.	Re-screw the upper cover.
Airpolishing handpiece leakage.	Tail line seal ring damaged, deformed or missing.	Replace seal ring.
Handpiece plug difficult.	Handpiece snap ring deformation	Replace snap ring.

Note: If the fault cannot be removed, please contact your local distributor or manufacturer.

4 Cleaning, Disinfection and Sterilization

4.1 Initial processing

4.1.1 Processing principles

It is only possible to carry out effective sterilization after the completion of effective cleaning and disinfection. Please ensure that, as part of your responsibility for the sterility of products during use, only sufficiently validated device and product-specific procedures are used for cleaning/disinfection and sterilization, and that the validated parameters are adhered to during every cycle.

Please also observe the applicable legal requirements in your country as well as the hygiene regulations of the hospital or clinic, especially with regard to the additional requirements for the inactivation of prions.

4.1.2 Post-operative treatment

The post-operative treatment must be carried out immediately, no later than 30 minutes after the completion of the operation. The steps are as follows:

Let the device work for 20-30 seconds at maximum water volume to separately flush the Air polishing handpiece, and nozzle;

Remove the handpieces from the device and rinse away the dirt on the surface of handpieces and their accessories with pure water (or distilled water/deionized water);

Dry the handpieces and its accessories with a clean, soft cloth and place it in a clean tray.

Precautions:

- 1) The water used here must be pure water, distilled water or deionized water.

4.2 Cleaning

The cleaning of handpiece and its accessories should be performed no later than 24 hours after the operation.

The cleaning can be divided into automated cleaning and manual cleaning.

Automated cleaning is preferred if conditions permit.

4.2.1 Automated cleaning

The cleaner is proved to be valid by FDA, CE certification or in accordance with EN ISO 15883.

There should be a flushing connector connected to the inner cavity of the product.

The cleaning procedure is suitable for the handle, and the flushing period is sufficient.

It is recommended to use a washer-disinfector in accordance with EN ISO 15883.

For the specific procedure, please refer to the automated disinfection section in the section “Disinfection”.

Precautions:

1) The cleaning agent does not have to be pure water. It can be distilled water, deionized water or multi-enzyme. But please ensure that the selected cleaning agent is compatible with the handpiece.

2) The water temperature should not exceed 45°C, otherwise the protein will solidify and it is difficult to remove.

4.2.2 Manual cleaning

- Soak the handpieces and its accessories in a cleaning agent (such as multi-enzyme). The soaking time and concentration should at least reach the time and concentration specified by the detergent manufacturer;

- Carefully clean the surface of the handpieces and its accessories with a disposable soft cloth or soft brush to remove any visible dirt on the surface;

- Rinse the handpieces and its accessories under clean running water (desalted water, distilled water or deionized water) for at least 5 times with duration of no less than 60 seconds for each time.

- Check whether the cleaned parts are clean or damaged. If the cleaning is not complete, repeat the previous cleaning procedures. The intrinsic suitability of the handpieces and its accessories for effective cleaning using the above procedure was verified by a validated facility.

Precautions:

1) The cleaning agent used here must be compatible with the handpieces and only freshly prepared solutions can be used.

2) The water temperature should not exceed 45°C, otherwise the protein will solidify and it is difficult to remove.

4.3 Disinfection

Disinfection must be performed no later than 2 hours after the cleaning phase. Automated disinfection is preferred if conditions permit.

4.3.1 Automated disinfection

If possible, the disinfection cycle should be in accordance with EN ISO 15883. Please ensure that the following standards are met when selecting a sterilizer

system:

- The sterilizer is FDA approved, CE certified or in accordance with EN ISO 15883.
- Use high temperature disinfection function. The temperature does not exceed 134 °C. The temperature cannot exceed 20 minutes.
- The sterilizer has a flush connecting piece that is connected to the interior of the handpiece.
- The cleaning procedure is suitable for the handle and the flushing cycle is sufficient (5-10 minutes).
- Only distilled or deionized water with a small amount of microorganisms (<10cfu/ml) can be used for all rinsing steps. (For example, pure water that is in accordance with the European Pharmacopoeia or the United States Pharmacopoeia).
- The air used for drying must be filtered by HEPA.
- Regularly repair and inspect the disinfecter.

Cleaning and disinfecting steps by using Washer-disinfecter Carefully place the handpieces and its accessories in the disinfection basket. Fastening of the handpieces and its accessories if only permissible of they are freely moveable in the fixture. The handpieces and its accessories are not permitted to make contact with one another. Use a suitable rinsing adaptor, and attach the handpieces to the rinsingconnections of the washer-disinfecter so that the surface and internal water lines can be flushed during cleaning process.

Start the program.

After the program is finished, remove the handpieces and its accessories from the asher-disinfecter, inspect (refer to section “Inspection and Maintenance”) and packaging (refer to chapter “Packaging”). Dry the handpieces and its accessories repeatedly if necessary (refer to section “Drying”).

The intrinsic suitability of the handpieces and its accessories for effective cleaning and disinfection using the above automated cleaning and disinfection procedures was verified by a certified facility. (Use the washer-disinfecter of Shandong Xinhua Medical Instrument Co., Ltd. located in Zibo City, Shandong Province, which complies with EN ISO 15883).

Precautions:

- 1) Before use, you must carefully read the operating instructions provided by the device manufacturer to familiarize yourself with the disinfection process and precautions.
- 2) With this device, cleaning, disinfection and drying will be carried out together.
- 3) Cleaning: (a) The water temperature should not exceed 45°C, otherwise the protein will solidify and it is difficult to remove. (b) The solution used can be pure water, distilled water, deionized water or multi-enzyme solution, etc., and only freshly prepared solutions can be used. (c) The cleaning agent must be compatible with the handpiece. Please follow the concentration and contact

time provided by manufacturer.

4.3.2 Manual disinfection

Tools: containers for disinfectant, water guns, air guns, trays Place the handpieces and its accessories in a disinfectant (e.g.75% medical alcohol or 2% glutaraldehyde solution) for at least the time specified by the manufacturer. Remove the handpieces and its accessories from the disinfectant and rinse it with purified water, distilled water or deionized water for at least 5 times for not less than 60 seconds of each time.

Dry the handpieces and its accessories with filtered compressed air (maximum pressure: 3 bar).

After the program is finished, remove the handpieces and its accessories from the washer-disinfector, inspect (refer to section “Inspection and Maintenance”) and packaging (refer to chapter “Packaging”). Dry the handpieces and its accessories repeatedly if necessary (refer to section “Drying”).

Verification of the fundamental suitability of the handpieces and its accessories for effective manual cleaning and disinfection was provided by a verified testing laboratory.

Precautions:

- 1) The disinfectant used to configure the disinfectant must be compatible with the handpieces and cleaning agent, and must be tested effective (e.g., DGHM, FDA approved or CE certified).
- 2) The disinfectant must be used in accordance with the concentration and contact time specified by manufacturer.
- 3) The disinfectant used must be freshly prepared solutions and no foaming is allowed.

4.4 Drying

If your cleaning and disinfection process does not have an automatic drying function, dry it after cleaning and disinfection.

Methods:

- 1) Spread a clean white paper (white cloth) on the flat table, point the handpieces and its accessories against the white paper (white cloth), and then dry the handpieces and its accessories with filtered dry compressed air (maximum pressure 3 bar). Until no liquid is sprayed onto the white paper (white cloth), the drying is completed.
- 2) It can be dried directly in a medical drying cabinet (or oven). The recommended drying temperature is 80°C~120°C and the time should be 15~40 minutes.

Precautions:

- 1) The drying of product must be performed in a clean place.
- 2) The drying temperature should not exceed 138°C;
- 3) The device used should be inspected and maintained regularly.

4.5 Inspection and maintenance

- 1) Check the handpieces and its accessories. If there is still visible stain on the handpieces and its accessories after cleaning/disinfection, the entire cleaning/disinfection process must be repeated.
- 2) Check the handpieces and its accessories. If it is obviously damaged, smashed, detached, corroded or bent, it must be scrapped and not allowed to continue to be used.
- 3) Check the handpiece. If the structural parts are broken, please replace it before use. But the replaced parts must be cleaned, disinfected and dried.
- 4) Do not use the machine when the machine is being cleaned/disinfected/sterilized.

4.6 Packaging

The disinfected and dried handpieces and their accessories are assembled and quickly packaged in a medical sterilization bag (or special holder, sterile box).

Precautions:

- 1) The package used conforms to ISO 11607;
- 2) It can withstand high temperature of 138°C and has sufficient steam permeability;
- 3) The packaging environment and related tools must be cleaned regularly to ensure cleanliness and prevent the introduction of contaminants;
- 4) Avoid contact with parts of different metals when packaging.

4.7 Sterilization

Use only the following steam sterilization procedures (fractional pre-vacuum procedure*) for sterilization, and other sterilization procedures are prohibited:

The steam sterilizer complies with EN13060 or is certified according to EN 285 to comply with EN ISO 17665;

The highest sterilization temperature is 138°C;

The sterilization time is at least 4 minutes at a temperature of 132°C / 134°C and a pressure of 2.0 bar ~ 2.3 bars.

Allow a maximum sterilization time of 20 minutes at 134°C.

Verification of the fundamental suitability of the products for effective steam sterilization was provided by a verified testing laboratory.

Precautions:

- 1) Only products that have been effectively cleaned and disinfected are allowed to be sterilized;
- 2) Before using the sterilizer for sterilization, read the Instruction Manual provided by the device manufacturer and follow the instructions.
- 3) Do not use hot air sterilization and radiation sterilization as this may result in damage to the product;
- 4) Please use the recommended sterilization procedures for sterilization. It is not recommended to sterilize with other sterilization procedures such as ethylene oxide, formaldehyde and low temperature plasma sterilization. The

manufacturer assumes no responsibility for the procedures that have not been recommended. If you use the sterilization procedures that have not been recommended, please adhere to related effective standards and verify the suitability and effectiveness.

*Fractionation pre-vacuum procedure: a procedure for steam sterilization by repeating pre-vacuum, the procedure used here is steam sterilized by three pre-vacuums.

5 Maintenance, storage and transportation

5.1 Maintenance

5.1.1 It is recommended to install air drying device (such as freezing dryer) in advance before using air polishing device. And check drying device every day to ensure it work normally. Otherwise it may be easy to cause prophylaxis powder agglomerating. And the agglomerating will cause the device or handpiece blocked.

5.1.2 Check sealing ring on the handpiece, tail line, powder tank, water bottle regularly. If finding defects such as rupture, deformation or falling off, please refer to the instructions and replace them in time, the accessories are equipped with sealing rings of corresponding specifications.

5.1.3 Check the air inlet interface filter once a month to confirm whether there is impurity in the filter. If there is impurity, replace the filter in time, and check the cleanliness of the air compressor and the environment where it is located. If there is no impurity, it is recommended to replace the filter every 24 months. Spare filters are included in accessories. The way to replace filter are shown in Figure 9.

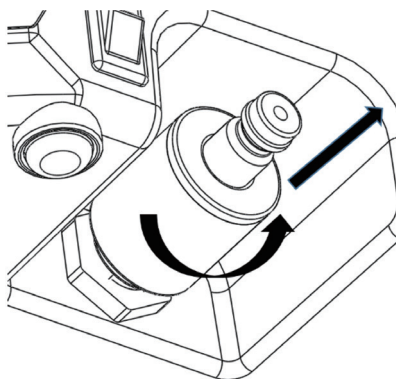

Fig. 8 Schematic diagram of filter replacement

5.2 Storage

5.2.1 This device should be carefully placed away from the source, and should

be installed or stored in a cool, dry and ventilated place.

5.2.2 Do not mix with toxic, corrosive, flammable and explosive articles during storage.

5.2.3 The product should be stored in an environment where the relative humidity is 10% ~ 93%, the atmospheric pressure is 70kPa ~ 106kPa, and the temperature is -20°C ~ + 55°C.

5.2.4 When this device is not in use for a long time, it should be powered on and ventilated once a month, at least five minutes each time.

5.3 Transportation

5.3.1 Excessive impact and shake should be prevented during transport. Lay it carefully and lightly.

5.3.2 Do not put it together with dangerous goods during transport.

5.3.3 Avoid being exposed to sun, rain, and snow during transport.

6 Environment protection

Please discard waste, debris and expired machines or components in accordance with local regulations.

Part	Toxic or harmful substances or elements					
	(Pb)	(Hg)	(Cd)	(Cr6+)	(PBB)	(PBDE)
Main unit	○	○	○	○	○	○
Motor handpiece	○	○	○	○	○	○
Dental contra-angle	○	○	○	○	○	○
Mechanical elements, including bolts, nuts, washers, etc.	○	○	○	○	○	○

○: Indicates that the content of the toxic substance in all homogeneous materials of the part is below the limit requirement stipulated in SJ/T-11363-2006 Limit Requirements for Toxic and Hazardous Substances in Electronic Information Products.

×: indicates that the content of the toxic substance in at least one of the homogeneous materials of the part exceeds the limit requirement specified in SJ/T-11363-2006. Please dispose according to the local laws or consult with dealer from whom you purchased it about waste disposal.

7 After service





















We offer one year free repair to the device according to the warranty card. The repair of the device should be carried out by professional technician. We are not responsible for any irretrievable damage caused by non-professional person.

This product is a precision device. If there is problem that needs to be repaired, returned to Woodpecker or handled by professionals is recommended. If any component part needs to be replaced, please contact Woodpecker for relevant information. Please use accessories or component parts provided or approved by Woodpecker. Using other accessories or component parts may cause equipment failure and unacceptable risks.

8 European authorized representative

EC REP MedNet EC-Rep GmbH
Borkstrasse 10 · 48163 Muenster · Germany

9 Symbol instruction

	Follow Instructions for Use		CE marked product
	Date of manufacture		Manufacturer
	Type B applied part		Recovery
	Handle with care		Keep dry
IPX0	Ordinary device	IPX1	Anti-drip device
	Used indoor only		Purging mode
	Alternating current		Foot switch
	Protective earthing		Sterilization under high temperature
	Power Switch	DC30V	30V DC
	Direct current		Cooling water or flushing water
	Appliance compliance WEEE directive		
	Storage condition, humidity limit: 10% ~ 93%		
	Storage condition, air pressure limit: 70kPa ~ 106kPa		



Storage condition, temperature limit: -20°C ~ +55°C

10 EMC-Declaration of conformity

A list of all cables are replaceable by the RESPONSIBLE ORGANIZATION :

Port No.	Name	Type*	Cable maximum lengths
1	Enclosure	N/E	—
2	AC Mains	AC power port	1.5m
3	Ultrasonic handpiece Cable	PATIENT COUPLING PORT	1.5m
4	Airpolishing handpiece Cable	PATIENT COUPLING PORT	1.7m
5	FOOT sw. Cable	SIP / SOP PORT	2.4m
6	DC Mains of adapter	DC power port	1.5m

Guidance and manufacturer's declaration - electromagnetic emissions

The model AP-B is intended for use in the electromagnetic environment specified below. The customer or the user of the model AP-B should assure that it is used in such an environment.

Emissions test	Compliance	Electromagnetic environment - guidance
RF emissions CISPR 11	Group 1	The model AP-B RF energy only for its internal function. Therefore, its RF emissions are very low and are not likely to cause any interference in nearby electronic equipment.
RF emissions CISPR11	Class B	
Harmonic emissions IEC 61000-3-2	Class A	
Voltage fluctuations / flicker emissions IEC 61000-3-3	Complies	

Guidance & Declaration — electromagnetic immunity

The model AP-B is intended for use in the electromagnetic environment specified below. The customer or the user of the model AP-B should assure that it is used in such an environment.

Immunity test	IEC 60601 test level	Compliance level	Electromagnetic environment - guidance

Electrostatic discharge (ESD) IEC 61000-4-2	± 8 kV contact ± 15 kV air	± 8 kV contact ± 15 kV air	Floors should be wood, concrete or ceramic tile If floors are covered with synthetic material, the relative humidity should be at least 30 %.
Electrical fast transient/burst IEC 61000-4-4	± 2 kV for power supply lines ± 1 kV for Input/output lines	± 2 kV for power supply lines ± 1 kV for interconnecting cable	Mains power quality should be that of a typical commercial or hospital environment.
Surge IEC 61000-4-5	± 1 kV line to line ± 2 kV line to earth	Line-to-line--- $\pm 0,5$ kV, ± 1 kV Line-to-ground--- $\pm 0,5$ kV, ± 1 kV, ± 2 kV	Mains power quality should be that of a typical commercial or hospital environment.
Voltage dips, short interruptions and voltage variations on power supply input lines IEC 61000--11	0 % UT; 0,5 cycle At 0° , 45° , 90° , 135° , 180° , 225° , 270° and 315° 0 % UT; 1 cycle and 70 % UT; 25/30 cycles Single phase: at 0° 0 % UT; 250/300 cycle	0 % UT; 0,5 cycle At 0° , 45° , 90° , 135° , 180° , 225° , 270° and 315° 0 % UT; 1 cycle and 70 % UT; 25/30 cycles Single phase: at 0° 0 % UT; 250/300 cycle	Mains power quality should be that of a typical commercial or hospital environment If the user of the model require continued operation during power mains interruptions, it is recommended that the model be powered from an uninterruptible power adapter or a battery.
Power frequency (50/60 H) magnetic field IEC 61000-4-8	30 A/m, 50 Hz and 60 Hz	30 A/m, 50 Hz and 60 Hz	Power frequency magnetic fields should be at levels characteristic of a typical location in a typical commercial or hospital environment.

NOTE UT is the ac mains voltage prior to application of the test level.

Guidance & Declaration - Electromagnetic immunity

The model AP-B is intended for use in the electromagnetic environment specified below. The customer or the user of the model AP-B should assure that it is used in such an environment.

Immunity test	IEC 60601 test level	Compliance level	Electromagnetic environment - guidance
---------------	----------------------	------------------	--

<p>Conducted RF IEC 61000-4-6 Conducted RF IEC 61000-4-6 Radiated RF IEC 61000-4-3</p>	<p>3 V, 0.15 MHz – 80 MHz, 6 V in ISM bands between 0.15 MHz – 80 MHz, 80 % AM at 1 kHz 3 V/m and 10 V/m, 80 MHz – 2,7 GHz, 80 % AM at 1 kHz 385 MHz, pulse modulation 18 Hz, 27 V/m; 450 MHz, FM +/- 5 kHz deviation 1 kHz sine, 28 V/m; 710 MHz, 745 MHz, 780 MHz, pulse modulation 217 Hz, 9 V/m; 810 MHz, 870 MHz, 930 MHz, pulse modulation 18 Hz, 28 V/m; 1,720 MHz, 1,845 MHz, 1,970 MHz, pulse modulation 217 Hz, 28 V/m; 2,450 MHz, pulse modulation 217 Hz, 28 V/m; 5,240 MHz, 5,500 MHz, 5,785 MHz, pulse modulation 217 Hz, 9 V/m</p>	<p>3 V, 0.15 MHz – 80 MHz, 6 V in ISM bands between 0.15 MHz – 80 MHz, 80 % AM at 1 kHz 3 V/m and 10 V/m, 80 MHz – 2,7 GHz, 80 % AM at 1 kHz 385 MHz, pulse modulation 18 Hz, 27 V/m; 450 MHz, FM +/- 5 kHz deviation 1 kHz sine, 28 V/m; 710 MHz, 745 MHz, 780 MHz, pulse modulation 217 Hz, 9 V/m; 810 MHz, 870 MHz, 930 MHz, pulse modulation 18 Hz, 28 V/m; 1,720 MHz, 1,845 MHz, 1,970 MHz, pulse modulation 217 Hz, 28 V/m; 2,450 MHz, pulse modulation 217 Hz, 28 V/m; 5,240 MHz, 5,500 MHz, 5,785 MHz, pulse modulation 217 Hz, 9 V/m</p>	<p>Portable and mobile RF communications equipment should be used no closer to any part of the models AP-B, including cables, than the recommended separation distance calculated from the equation applicable to the frequency of the transmitter. Recommended separation distance $d=1.2 \times P^{1/2}$ $d=2 \times P^{1/2}$ $d=1.2 \times P^{1/2}$ 80 MHz to 800 MHz $d=2.3 \times P^{1/2}$ 800 MHz to 2.7 GHz where P is the maximum output power rating of the transmitter In watts (W) according to the transmitter manufacturer and d Is the recommended separation distance in meters (m). Field strengths from fixed RF transmitters, as determined by an electromagnetic site survey, a should be less than the compliance level in each frequency range. b Interference may occur In the vicinity of equipment marked with the following symbol: </p>
--	---	---	--

NOTE 1 At 80 MHz - 800 MHz, the higher frequency range applies.
NOTE 2 These guidelines may not apply in all situations. Electromagnetic propagation is affected by absorption and reflection from structures, objects and people.

a Field strengths from fixed transmitters, such as base stations for radio (cellular/cordless) telephones and land mobile radios, amateur radio, AM and FM radio broadcast and TV broadcast cannot be predicted theoretically with accuracy. To assess the electromagnetic environment due to fixed RF transmitters, an electromagnetic site survey should be considered. If the measured field strength in the location in which the model is used exceeds the applicable RF compliance level above, the model should be observed to verify normal operation. If abnormal performance is observed, additional measures may be necessary, such as reorienting or relocating the model.

b Over the frequency range 150 kHz to 80 MHz, field strengths should be less than 3V/m.

Recommended separation distances between portable and mobile RF communications equipment and the model

The model is intended for use in electromagnetic environment in which radiated RF disturbances is controlled. The customer or the user of the model can help prevent electromagnetic interference by maintaining a minimum distance between portable and mobile RF communications equipment (transmitters) and the model is recommended below, according to the maximum output power of the communications equipment.

Rated maximum output power of transmitter W	Separation distance according to frequency of transmitter m		
	150kHz to 80MHz $d=1.2 \times P^{1/2}$	80MHz to 800MHz $d=1.2 \times P^{1/2}$	800MHz to 2,7GHz $d=2.3 \times P^{1/2}$
0,01	0.12	0.12	0.23
0,1	0.38	0.38	0.73
1	1.2	1.2	2.3
10	3.8	3.8	7.3
100	12	12	23

For transmitters rated at a maximum output power not listed above, the recommended separation distance d in meters (m) can be estimated using the equation applicable to the frequency of the transmitter, where P is the maximum output power rating of the transmitter in watts (W) accordable to the transmitter manufacture.

NOTE I At 80 MHz - 800 MHz, the separation distance for the higher frequency range applies.

NOTE II These guidelines may not apply in all situations. Electromagnetic propagation is affected by absorption and reflection from structures, objects and people.

The device has been tested and homologated in accordance with EN 60601-1-2 for EMC. This does not guarantee in any way that this device will not be affected by electromagnetic interference. Avoid using the device in high electromagnetic environment.

11 Statement

Woodpecker reserves the right to change the design of the device, the technique, fittings, instruction manual and the content of the original packing list at any time without further notice. The pictures are only for reference. The final interpretation rights belong to Guilin Woodpecker Medical Instrument Co., Ltd. The appearance of the product was authorized patent, and counterfeit will be sued! (Please refer to the packaging label for the date of manufacture. Service life: 10 years)

Scan and Login website
for more information



Guilin Woodpecker Medical Instrument Co., Ltd.
Information Industrial Park, Guilin National High-Tech
Zone, Guilin, Guangxi, 541004 P. R. China
Sales Dept.: +86-773-5873196
[Http://www.glwoodpecker.com](http://www.glwoodpecker.com)
E-mail: woodpecker@glwoodpecker.com



MedNet EC-Rep GmbH
Borkstrasse 10 · 48163 Muenster · Germany

AP-B Dental Scaler and Air Polisher Warranty Card

Name of Customer		(I) For Distributor
Address Details		
Postal Code		
Tel		
Model		
Product No.		
Handpiece No.		
Purchase Date		
Contact Person		
Date	Maintenance Record	Repairer

AP-B Dental Scaler and Air Polisher Warranty Card

Name of Customer		(II) Return to Manufacturer
Address Details		
Postal Code		
Tel		
Model		
Product No.		
Handpiece No.		
Purchase Date		
Contact Person		
Date	Maintenance Record	Repairer

Guilin Woodpecker Medical Instrument Co., Ltd.
Information Industrial Park, Guilin National High-Tech
Zone, Guilin, Guangxi, 541004 P. R. China

Europe Sales Dept. Tel: +86-773-5873196
 North America, South America & Oceania Sales Dept. Tel:
 +86-773-5873198
 Asia & Africa Sales Dept. Tel: +86-773-5855350
 Fax: +86-773-5822450
 E-mail: woodpecker@glwoodpecker.com, sales@glwoodpecker.com
 Website: http://www.glwoodpecker.com

Distributor:	Seal
--------------	------

Guilin Woodpecker Medical Instrument Co., Ltd.
Information Industrial Park, Guilin National High-Tech
Zone, Guilin, Guangxi, 541004 P. R. China

Europe Sales Dept. Tel: +86-773-5873196
 North America, South America & Oceania Sales Dept. Tel:
 +86-773-5873198
 Asia & Africa Sales Dept. Tel: +86-773-5855350
 Fax: +86-773-5822450
 E-mail: woodpecker@glwoodpecker.com, sales@glwoodpecker.com
 Website: http://www.glwoodpecker.com

Distributor:	Seal
--------------	------

Warranty Instruction

I Period validity:

One year's free repair for the whole unit (except for the easily-consumed parts) from the date of purchase. Lifetime maintenance.

II Range of warranty:

Within the warranty period of validity, we are responsible for any troubles caused by quality problems or products technique and structure.

III The following are beyond our warranty:

1. The damage caused by disobeying the operation instruction or lack of the needed condition.
2. The damage caused by unsuitable operation or disassembly without authorization.
3. The damage caused by unadvisable transportation or preservation.
4. There isn't the seal of distributor or the warranty card isn't filled in completed.

Warranty Instruction

I Period validity:

One year's free repair for the whole unit (except for the easily-consumed parts) from the date of purchase. Lifetime maintenance.

II Range of warranty:

Within the warranty period of validity, we are responsible for any troubles caused by quality problems or products technique and structure.

III The following are beyond our warranty:

1. The damage caused by disobeying the operation instruction or lack of the needed condition.
2. The damage caused by unsuitable operation or disassembly without authorization.
3. The damage caused by unadvisable transportation or preservation.
4. There isn't the seal of distributor or the warranty card isn't filled in completed.

Harm of fake products



and **DTE** are two brands of Guilin woodpecker medical instrument company. Recently, growing fake ultrasonic scaler handpieces, tips curing lights are produced and sold on the market, which do harm to users' interest. On this issue, We Woodpecker will crack down fake products and provide safe and secure medical instrument products.

1. Harm of fake ultrasonic scaler handpieces.

- 1.1 Fake handpieces with poor-designed inner structure can lead to frequent power leakage, which may cause medical accidents.
- 1.2 Material used on fake handpieces don't pass biocompatible test, which can easily lead to irritability and poisoning.
- 1.3 Fake handpieces have quality problems of overheating, non-vibration and cracking, which cause ultrasonic scalers out of order.
- 1.4 Fake handpieces can't be compatible with ultrasonic scalers, thus leading to circuit burn out.

2. Harm of fake scaler tips.

- 2.1 Fake tips are low in toughness, poor in resistance and easy to crack, thus easily cause medical accident.
- 2.2 Fake tips' screw threads are roughly processed, which can cause handpiece's screw loosening and cracking.
- 2.3 Material used on fake tips is inferior and easily rusting, which can cause infection of patient.
- 2.4 Fake tips have used problem of poor water-spraying, bad screw-thread fit and water leaking, which leads ultrasonic scalers work wrongly.

3. Harm of fake curing light.

- 3.1 Fake curing light's batteries can cause self-ignite, even explosion with poor-quality material and no complete charging management.
- 3.2 Light intensity of fake curing light is not constant, when battery level goes down under 60%, it would lead to incomplete solidification of resin, causing secondary dental caries.

